



Vorne Industries

87/256
Event Counter Display
User's Manual

Chapter 1	Setting Up Your Display For Operation	1
1.1	Accessing Wiring Connections And Selection Switches	3
1.2	Operation	3
1.3	Setting The DIP Switches For Your Application	4
	Run and Program Modes	4
	DIP Switch or VDP4 Selection	4
	Unit Type	4
	Input 2 Input Rate	5
	Input 1 Input Rate	5
	Active Level	5
	Counter Mode	5
1.4	Connecting Power To The Display	7
1.5	Wiring and Specifications	7
	Reset	7
	Input 1 and Input 2	7
	Output Voltage	8
	Wiring	8
1.6	Basic Information About Serial Communication Ports	9
1.7	RS-232 Communication To A Single Display	9
	Selecting RS-232 Communication	9
	RS-232 Connectors	10
	Wiring Diagram For An RS-232 Host Device To One Display	10
	Guidelines For Wiring RS-232 Devices	11
1.8	RS-422 Or RS-485 Communication To One Or More Displays	11
Chapter 2	Using The Simple Packet Protocol	12
2.1	Simple Packet Communication Format	12
2.2	Simple Packet Commands	13
	Simulate An Input	14
	Display Data	14
	Flash Data	14
	Change Color (For Tri-color Display's)	15
	Activate Relay	15
2.3	Addressing Multiple Displays	16
	Unit Address	16

2.4 Using Checksums And Command Acknowledgments	17
Chapter 3 Advanced Features Of the 87 Series Display	18
3.1 VDP4 Options	18
Display Justification	18
Leading Zeroes	18
Fixed Decimal Point After Digit	18
Number of Display Digits	18
Counter Mode	18
Input Active Level	19
Debounce Time	19
Counter Reload Value	19
Scale Factor	19
Save on Power Down	19
Count Below Zero	19
Trigger Value	19
Relay Setup	19
Baud Rate	19
Data Bits	20
Terminator	20
Unit Address	20
Member of Group(s)	20
Checksum	20
Command Acknowledgment	20
Output Transmission	20
Appendix A Operating Specifications	21
Appendix B Character Set Listing	22
Appendix C Display Dimensions	23

Notice Of Disclaimer

While the information in this manual has been carefully reviewed for accuracy, Vorne Industries, Inc. assumes no liability for any errors, or omissions in the information. Vorne Industries also reserves the right to make changes without further notice to any products described in this manual.

Chapter 1 Setting Up Your Display For Operation

This chapter describes how to set up the display hardware for operation, including setting the dip switches, connecting power, wiring the counter inputs, and wiring to the serial communication port. There are many references in this chapter to the term **input device**. The input device is whatever device will be providing a input signal to the 87/256 display. Some typical input devices are foot switches, relay contacts, 3 wire proximity sensors, PLC outputs and photoelectric eyes.

1.1 Accessing Wiring Connections And Selection Switches

All external power and signal connections to the display are made to printed circuit board mounted terminal strips. These terminal strips, as well as a 10 position DIP switch can be accessed by removing the back panel user access plate.



WARNING - SHOCK HAZARD

Always completely disconnect power from the display before opening the user access plate. Do not reapply power to the display until the access plate has been reinstalled and securely closed.

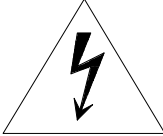

There are two 7/8" conduit openings on the back panel of the display, provided for bringing external wiring into the display enclosure. If these conduit openings will not be used for wiring, these openings can be filled with plastic plugs (Caplugs Part Number BP-7/8) which are provided with the display.

The left most conduit opening is provided for power wiring, the right most for signal wiring. **It is not recommended to run power wiring and signal wiring in the same conduit!**

1.2 Operation

The 87/256 event counter displays the number of inputs received on a 2 to 8 digit display field. The count value is stored in a EEPROM which makes it possible for the unit to retain the last count in the event of power loss, without battery back-up. The scale factor for each input is set to 1 at the factory. The scale factor can be modified in the field by using 87 Express, a Windows based Setup Utility, or via Mini-T a handheld terminal available from Vorne. The display value is the product of the scale factor and the actual counts received since the last reset.

An RS232 serial port is provided standard with each counter. The serial port can be used for customizing the operation of the unit. See chapter 3 for additional information on customization.

The serial port also allows remote user access to the following features:

- Inputs can be simulated & an optional relay output can be controlled with serial commands.
- Data such as time can be sent to the display as a temporary message.
- An optional RS-485 converter increases the communications distance up to 4000 feet.

1.3 Setting The DIP Switches For Your Application

DIP switch changes are only acknowledged at power up. Factory defaults are shown in gray.

Run and Program Modes

1	Mode
ON	Program
OFF	Run

For normal operation the Run/Program switch should be set to Run (off). Setting the unit to Program mode allows the unit to be customized using VDP4 and to run one of two diagnostic routines. If DIP switch 2 is off, the display cycles thru the following display diagnostic.

- a. Error status Should show E0. E1 or E2 indicates a memory error.
- b. Unit Address Default value is 00.
- c. Red segment test The unit will turn on 1 segment at a time A thru F and DP.
- d. Green segment test. For a single color display a blank screen will be displayed.
- e. All segments ON.
- f. Unit type. 0 = 87/256
- g. --. This is a separator between the Unit type and the Software version.
- h. Software version. This number is displayed on two consecutive screens (Ex: 1.1.3).

If DIP switch 2 is on, the display runs a DIP switch diagnostic. This diagnostic displays the HEX value of DIP switches 3 thru 10. (switches 3 to 6 = MSD, switches 7 to 10 = LSD)

DIP Switch or VDP4 Selection

For normal operation the Settings DIP switch should be set to DIP switch (on).

In program mode, Switch 2 selects between Display test (off) and DIP switch test (on). For VDP4 customized units DIP switch 2 will be set to VDP4 (off) and switches 3-10 will be ignored.

2	Settings
ON	DIP Switch
OFF	VDP4

Unit Type

The **unit type** of your 87 series display determines how the unit will operate. There are four unit types available, Event Counter, Rate Monitor, Elapsed Timer and Production Monitor. The functionality of DIP switches 5 to 10 is determined by this selection.

3	4	Unit Type
OFF	OFF	87/256 Event Counter
OFF	ON	87/415 Rate Monitor
ON	OFF	87/705 Elapsed Timer
ON	ON	87/805 Production Monitor

Input 1 Input Rate

The input rate for Input 1 is field programmable to low or high speed by setting this DIP switch. When using a input device such as a switch or a relay contact, set the input rate to low speed. This will prevent false counts caused by contact bounce. For input devices such as proximity sensors and photoelectric eyes, set the input rate to high speed. Shielded wire for the input is recommended when the unit is set to high speed but not required for low speed.

5	Input 1 Rate
ON	High speed
OFF	Low speed

Input 2 Input Rate

The input rate for Input 2 is field programmable to low or high speed by setting this DIP switch. When using a input device such as a switch or a relay contact, set the input rate to low speed. This will prevent false counts caused by contact bounce. For input devices such as proximity sensors and photoelectric eyes, set the input rate to high speed. Shielded wire for the input is recommended when the unit is set to high speed but not required for low speed.

6	Input 2 Rate
ON	High speed
OFF	Low speed

Active Level

Active level of Input 1 and Input 2 can be configured as active high or active low. For sinking inputs the typical selection is active low. This setting will allow the display value to be changed when the input is connected to ground. For sourcing inputs the typical selection is active high. This setting will allow the display value to be changed when the input is connected to +VDC.

7	Active Level
ON	High
OFF	Low

Counter Mode

The inputs of the counter can be configured to meet your application. Input 1 can be set to count up, count down, or as a quadrature input. Input 2 can be set to select count / rate, count up, count down, select count direction, or as a quadrature input.

- The default scale factor setting for each input is 1.
- Both inputs can occur simultaneously without loss of count.
- In modes where count down inputs are available, if the count is decremented below zero, the display will display a negative sign immediately to the left of the count value.

- If the count value exceeds the display size, the least significant digits of the count will be displayed (e.g. count =1059, unit is a 3 digit display, actual displayed value will be 059).

Mode 0 will set input 1 as a count up input and input 2 will be ignored.

Mode 1 sets both inputs as count up inputs.

Mode 2 sets both inputs as count down inputs.

Mode 3 sets input 1 as a up input and input 2 as a down input.

Mode 4 sets input 1 as the count input and input 2 will select whether the unit should count up (input 2 open) or count down (input 2 active).

Mode 5 sets the inputs to quadrature X 1. The counter will count up on a negative going edge of input 1 if input 2 is low. The counter will count down on a positive going edge on input 1 if input 2 is low.

Mode 6 sets the inputs to quadrature X 2. Mode 7 is similar in operation to Mode 6. However both edges of input 1 are counted resulting in a doubling of the resolution of the encoder.

Mode 7 will set input 1 as a count up input where input 2 selects whether the count is displayed (input 2 open) or the rate per minute is displayed (input 2 active). The rate per minute is calculated and updated on a one second sample. The rate will drop to zero if no inputs are received for six seconds.

8	9	10	Mode	Description	
				Input 1	Input 2
OFF	OFF	OFF	0	INPUT	N/A
OFF	OFF	ON	1	UP	UP
OFF	ON	OFF	2	DOWN	DOWN
OFF	ON	ON	3	UP	DOWN
ON	OFF	OFF	4	COUNT	UP / DOWN
ON	OFF	ON	5	QA	QB X 1
ON	ON	OFF	6	QA	QB X 2
ON	ON	ON	7	INPUT	COUNT / RATE

1.4 Connecting Power To The Display

Power connections are made to the three pin POWER terminal strip (marked P1). Connect power to this terminal strip as shown below.

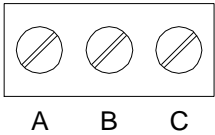
3 Pin POWER Terminal Strip (P1)	Pin	120 VAC Powered Units	12 VDC Powered Units
	A	120 VAC (Hot)	+ 12 VDC
	B	120 VAC (Neutral)	DC Ground
	C	Earth Ground	Earth Ground

Proper grounding is an important aspect of power wiring, both as a safety measure and for improved electrical noise immunity. **Always** connect Earth Ground to the 87/256 display.



WARNING

Terminal C (Earth Ground) must always be connected to a reliable low impedance earth ground. This provides a safety ground to the enclosure, as well as a return path for electrical noise.

The power requirements for all standard 87/256 display configurations are listed in Appendix A.

1.5 Wiring and Specifications

Reset

The reset input has an internal 10K pull-up resistor to +5 volts. Momentarily sinking this input to ground with a contact closure or open collector NPN transistor activates the reset function. The display value will be reset to 0 if a reset input is received. The Reset input is TTL or CMOS compatible with a minimum high of 3.5 VDC and a maximum low of 1.5 VDC. The reset line is active on the negative going edge.

Input 1 and Input 2

Input 1 and Input 2 have an internal 3.3K resistor to either +5 volts or signal ground depending on the selection of the SINK / SOURCE jumper. The SINK / SOURCE jumper (J2) is located to the lower left of the Input Terminal strip. Both inputs will be affected by the setting of this jumper. The factory default setting is SINK.

	SINK	SOURCE
Active state of input	Connect input to ground with a contact closure or open collector NPN transistor.	Connect input to +VDC with a contact closure or open collector PNP transistor.
Normal state of input	Pulled to +5 VDC thru a 3.3K resistor.	Pulled to Signal ground thru a 3.3K resistor.

Input characteristics

High Level	3.5 to 30 VDC
Low Level	0 to 1.5 VDC
Input loading	1.5mA to 10mA (5V-30V)
Leakage current accepted	500 uA
Low Speed	50 Hz (10 millisecond on/off time)
High Speed	4000 Hz (120 microsecond on/off time)

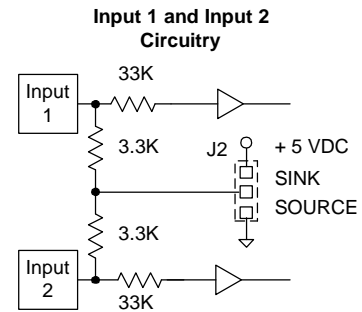

Output Voltage

A regulated +12VDC output voltage rated at 100mA is provided for auxiliary use.

Wiring

Input connections are made to the five pin INPUT terminal strip (marked P2). Connect inputs to this terminal strip as shown below.

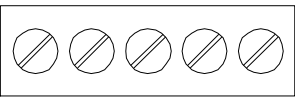
5 Pin INPUT Terminal Strip (P2)	Pin	Function
Pins 1 to 5 Input Terminal Strip 	1	Reset (RST)
	2	Input 1 (IN 1)
	3	Input 2 (IN 2)
	4	+ 12 VDC
	5	Signal GROUND (0VDC)

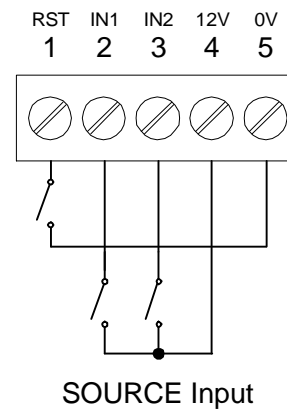
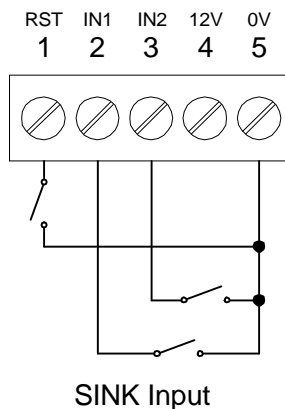
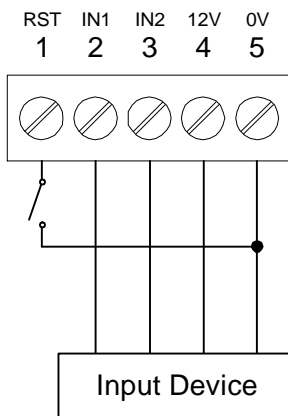

1.6 Basic Information About Serial Communication Ports

This section provides some basic background information regarding different types of serial communication ports. Each 87/256 display contains an RS-232 port. An RS-485 port (which is also compatible with RS-422 communication), is available via a plug in option board. Note: *Only one of the two ports can be used at any given time to communicate with a host device.*

RS-232 ports are the most common type of serial ports, although they are more common in an office environment than an industrial environment. This is because RS-232 can only be run for short distances (under 50 feet), and in environments where EMI (electromagnetic interference) is minimal. Also, one host RS-232 port is limited to directly communicating with one device.

RS-422 ports are very common in industrial environments. They are well suited for distances up to 4000 feet, and have substantially superior EMI immunity characteristics. Additionally, one host RS-422 port can communicate with a minimum of 10 devices without repeating the signal.

RS-485 ports are basically an improved version of RS-422, and in most cases are completely compatible with RS-422 devices (and vice versa). In fact, many newer products with built in RS-422 ports actually use driver circuits that meet the RS-485 specification (87 series displays fall into this class). RS-485 offers better EMI immunity characteristics, and improved drivers that have the ability to communicate with up to 32 devices without repeating the signal. There is sometimes confusion regarding RS-485 because it has an additional ability to communicate in both directions over one pair of wires, a feature not supported by RS-422 or by 87 series displays.

20 mA current loop was commonly used for industrial applications in the past but is less common today. To use a 20mA current loop serial port with an 87/256 display, all that is required is an external 20 mA current loop to RS-422 converter. Vorne can provide such a converter if your application requires it.

1.7 RS-232 Communication To A Single Display

This section provides the information necessary to successfully interface a host RS-232 port to one 87/256 display. If you would like to interface a host RS-232 port to multiple 87/256 displays, read this section as well as section 1.8.

Selecting RS-232 Communication

The RS-232 port is the standard communication port available in a 87/256.

RS-232 Connectors

The RS-232 port is available on pins 1 to 3 of the 3 pin communication port terminal strip (marked P3). The RS-232 terminal strip is shown below.

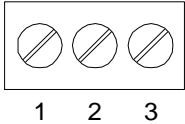
3 Pin COM PORT Terminal Strip (P3)	Pin	Function
Pins 1 to 3 RS-232 Port 	1	RS-232 Transmit Data (TxD)
	2	RS-232 Receive Data (RxD)
	3	Communication GROUND

Many host devices use either DB25 or DB9 connectors for their RS-232 ports. For your reference, two common RS-232 DB interfaces are shown below. They are the standard male DB25 interface, and the standard male IBM/AT® style DB9 interface.

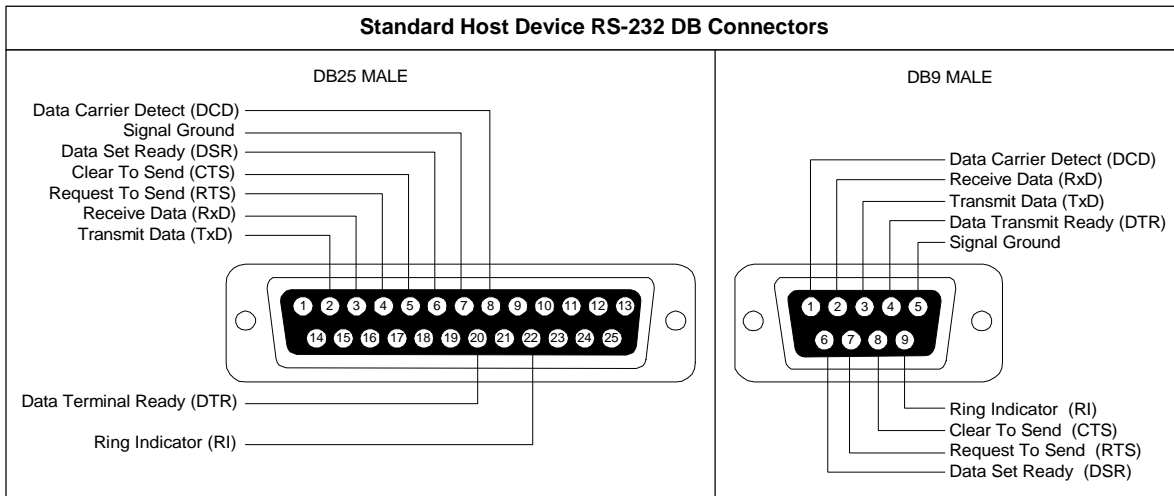

Wiring Diagram For An RS-232 Host Device To One Display

The only connections necessary for two way communication between a host device and an 87/256 display are the ones shown in the diagram below. Please refer to the Guidelines For Wiring RS-232 Devices section below for important wiring recommendations. For one way communication from the host to the display, the transmit data (TxD) line from the display (pin 1) does not need to be connected to the host device.

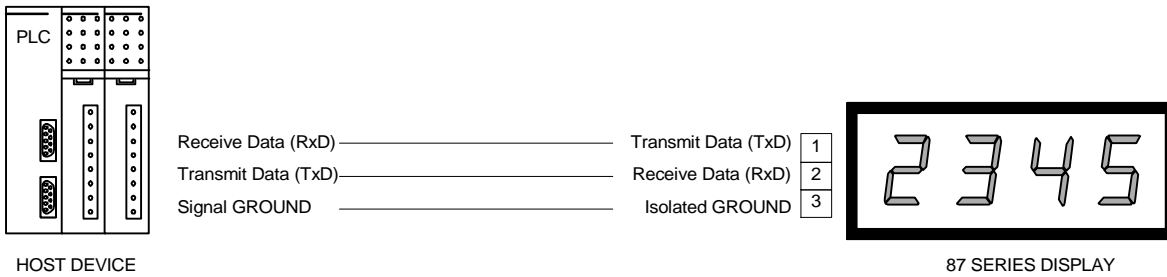

Guidelines For Wiring RS-232 Devices

For best results when wiring RS-232 devices please follow these guidelines:

1. Use a 50 foot maximum cable length.
2. Use a baud rate of 19,200 or less.
3. Use a shielded cable with the shield connected to Earth Ground *only at the 87/256 display*. Belden 9842 is a recommended cable.
4. Carefully check your equipment and cable to ensure that Earth Ground is *not* connected at both ends of the cable. If there is a significant difference in Earth Ground potential between the two ends of the cable, it could cause data transmission errors, or even damage to the RS-232 communication ports.
5. Keep the cable length as short as possible, and do not run the RS-232 cable parallel to any power cables.

1.8 RS-422 Or RS-485 Communication To One Or More Displays

To successfully interface a host RS-422 or RS-485 port to one or more 87/256 displays, please refer to the Add On module Users Manual. Note that the 87/256 display requires an optional communications board for opto-isolated RS-485 communications.

Chapter 2 Using The Simple Packet Protocol

This chapter describes the communication protocol of **Simple Packet**. This is for applications where you can control the data being transmitted to the display, but where you would like to access advanced features. These features include independently simulating inputs, addressing multiple displays, flashing the display, or controlling an optional relay in the display. The default communication settings of the 87/256 are 9600 Baud, 8 data bits, 1 stop bit, no parity, Unit address 0, Group address 0, and Carriage Return <CR> Line Terminator.

2.1 Simple Packet Communication Format

The format of **Simple Packet** communication is:

<SOH> Type Address : Command Data Terminator Checksum

<SOH> The symbol **<SOH>** represents the ASCII "Start Of Header" character (01 hex/1 decimal), and must be the first character of every transmission. Since the purpose of the **<SOH>** character is to mark the beginning of a new packet, it cannot appear anywhere else within the transmission.

Type Can be one of two ASCII characters (**S** or **s**), and must be the second character of every transmission. This character lets the display know if the serial data is meant for an individual address or a group address.

S Serial data for an individual address.
s Serial data for a group address.

If your application does not require addressing individual displays or groups of displays, you should use the type **s**. This will allow data that you send to be acted upon by every display that receives it (as explained below).

Address Can range from **0** to **255**, and is an optional part of the packet that specifies an actual unit or group address. If no address is included in the packet, the default address of **0** will be used.

Note that a transmitted *group* address of **0** is a broadcast to all units, regardless of what the internal address of each display is set to. Thus, when no addressing is required, you can skip the **Address** part of the packet, and rely on the fact that a default address of 0 will automatically be substituted. In this case, the complete header before the data would be **<SOH>s:** and the data will be acted on by all displays that receive it.

For more information about individual and group addressing see Section 2.3 Addressing Multiple Displays.

:	The ASCII "Colon" character (3A hex/58 decimal) must be included in every transmission, and is used to separate the header part of the packet from the data.
Command	Can contain one command string for the display. Command strings can be used to display data, simulate an input, flash data on the display, or control the optional relay. The available commands are fully described in Section 2.2 Simple Packet Commands.
Data	Any ASCII characters you wish to display (refer to Appendix B for a full character set listing). The control characters <SOH>, <CR> and <LF> cannot be used in the Data part of the packet, as they are reserved for marking the beginning and end of packets.
Terminator	A special ASCII character which marks the end of the data (and thus immediately follows it). Note that the symbol <CR> represents the ASCII "Carriage Return" character (0D hex/13 decimal), and the symbol <LF> represents the ASCII "Line Feed" character (0A hex/10 decimal). In cases where the host device transmits a <CR><LF> combination as the terminator, select <CR>.
Checksum	This is an optional part of the packet that can be used to provide an extra level of data validation. If used, the checksum immediately follows the Terminator character. Please request the Advanced Applications Guide if you are interested in using a checksum.

2.2 Simple Packet Commands

The command portion of the packet can contain one (and only one) command string for the display. Command strings can be used to Simulate inputs, display data, flash data on the display, change display color on tri-color displays, or control the optional relay. Each of these commands is fully described below.

To accomplish more than one command (e.g. flash data on the display and turn the relay on), you must send a separate packet for each command.

Remember that the control characters <SOH>, <CR> and <LF> cannot be used anywhere in the data portion of the packet, as they are reserved for marking the beginning and end of packets.

The following examples assume that addressing is not being used, and that Terminator has been selected as <CR>. Also note that the header of the packet <SOH>s: has the effect of broadcasting to all displays, overriding any group or individual address a display might be set to.

Simulate An Input

The **Input** command string begins with the ASCII character **I** (49 hex/73 decimal). Note that the **I** must be upper case. The rest of the data consists of a ASCII character which represent the input to simulate. The available inputs are:

<u>Input</u>	<u>ASCII Character</u>	<u>Hex/Decimal Representation</u>
Input 1	1	31 hex/49 decimal
Input 2	2	32 hex/50 decimal
Reset	R	52 hex/82 decimal

To Simulate...	Transmit
Input 1	<SOH>s:I1<CR>
Input 2	<SOH>s:I2<CR>
Reset	<SOH>s:IR<CR>

Display Data

Data to be displayed is preceded by the ASCII character **D** (44 hex/68 decimal). Note that the **D** must be upper case. The data will be displayed in a fixed (non-flashing) manner. Data sent to the unit using this command will remain on the display until an input is received or power loss.

To Show On The Display...	Transmit
1234	<SOH>s:D1234<CR>
888.8	<SOH>s:D888.8<CR>

Flash Data

Data to be displayed flashing is preceded by the ASCII character **F** (46 hex/70 decimal). Note that the **F** must be upper case. The data will be displayed flashing. Data sent to the unit using this command will remain on the display until an input is received or power loss.

To Flash On The Display ...	Transmit
1234	<SOH>s:F1234<CR>
888.8	<SOH>s:F888.8<CR>

Change Color (For Tri-color Display's)

Some 87 series displays are available with a tri-color display option. With the tri-color option, each digit color can be individually set to red, yellow or green.

The **Color** command string begins with the ASCII character **C** (43 hex/67 decimal). Note that the **C** must be upper case. The rest of the data consists of a string of upper case ASCII characters which represent the color each digit of the display should be set to, starting with the most significant (left most) digit. The available colors are:

<u>Color</u>	<u>ASCII Character</u>	<u>Hex/Decimal Representation</u>
Red	R	52 hex/82 decimal
Yellow	Y	59 hex/89 decimal
Green	G	47 hex/71 decimal

If the **C** command is sent with only one color character (for example **CR**), the entire display will be set to that color. The **Color** command takes effect as soon as it is received.

To Set The Display Color To...	Transmit
All Yellow	<SOH>s:CY<CR>
2 Digits Red, 2 Digits Green	<SOH>s:CRRGG<CR>

Activate Relay

An optional relay output board can be added to the 87/256 display for additional annunciation.

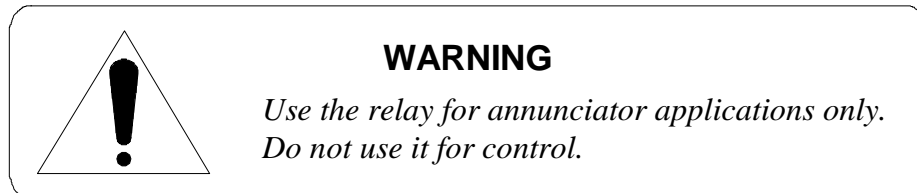

The **Relay** command string begins with the ASCII character **R** (52 hex/82 decimal). Note that the **R** must be upper case, and must be followed by one character (which determines what relay action will occur). The available actions are:

<u>Action</u>	<u>ASCII Character</u>	<u>Hex/Decimal Representation</u>
Turn relay on	1	31 hex/49 decimal
Turn relay off	0	30 hex/48 decimal
Sequence A	A	41 hex/65 decimal

Sequence A is a user definable relay sequence (e.g. cycle the relay 20 times with each cycle consisting of 1.0 second on and 2.0 seconds off), which can be triggered with one command. For more information about the user definable relay sequence, please refer to Chapter 3 Advanced Features Of The 87 Series Display.

To....	Transmit
Turn the relay on	<SOH>s:R1<CR>
Turn the relay off	<SOH>s:R0<CR>
Trigger Sequence A	<SOH>s:RA<CR>

2.3 Addressing Multiple Displays

Using an RS-422 or RS-485 network (described in the Add On Module Users Manual) together with addressing allows a host computer or PLC to communicate with specific individual displays or groups of displays in a network. Each display in the network may be assigned a unit address *and* a group address. If you do not need to address individual displays, or groups of displays, skip this section.

Unit Address

Individual unit addresses can range from **0** to **255**, allowing up to 256 displays to be individually addressed in a network. The factory default unit address is 0.

If a packet is directed to a specific unit address, only units set to that address will respond to the data. More than one display may use the same unit address. Remember, if the data in the packet is meant for a specific unit address, the serial data type **S** must follow the <SOH> character in the transmission packet (as shown in the examples below).

The following examples assume that **Unit Address** is set to **10**, checksums are not being used, and that **Terminator** has been selected as <CR>. Also note that an upper case **S** follows the <SOH> indicating that the serial data is intended for an individual display address, and the **D** command character is being used to display data.

To Show Only On Displays With A Unit Address Of 10...	Transmit
1234	<SOH>S10:D1234<CR>
888.8	<SOH>S10:D888.8<CR>

2.4 Using Checksums And Command Acknowledgments

Using checksums and command acknowledgments can improve the reliability of data transfer between the host device and the display. They are optional features of the simple packet protocol - either or both can be used.

Checksums allow the display to check if data has become corrupted during transmission from the host device to the display. Command acknowledgments are used to let the host device know if data received by the display can be acted upon (i.e. the data is valid for the command transmitted, and the command and data are appropriate for the particular display). If checksums are being used, command acknowledgments also provide a means of letting the host device know that the data was received with a proper checksum.

If you are interested in using checksums and/or command acknowledgment to improve data transfer reliability, please request the Advanced Applications Guide.

Chapter 3 Advanced Features Of the 87 Series Display

The 87/256 has been designed in such a way that it can be customized to meet a users specific requirements. The unit is shipped from the factory set to DIP switch settings. The DIP switch settings allow the user to select the Unit type, Input speed for input 1 and input 2, and the counter type. The DIP switch settings have been selected so that a majority of users can setup the display with minimal effort.

Additional settings such as right justified data, leading zeroes blanked, no fixed decimal point, and a factor of 1 are programmed at the factory and are not DIP switch selectable. Applications that do not fit the DIP switch settings can be accommodated by using VDP4 to customize the operation of the 87/256 display. *VDP4* is a Windows™ based utility that is available from Vorne. To bypass the DIP switch settings, DIP switch 2 should be set to VDP4 (off). Setting the unit to VDP4 settings allows the unit to operate with the settings that are stored in a EEPROM on the displays logic board.

For additional information on topics discussed in this chapter, request the *Advanced Applications Guide*.

3.1 VDP4 Options

The following is a list of 87/256 options that can be programmed using VDP4.

Display Justification

Available selections are Left or Right Justify.

Leading Zeroes

Available selections are Do Not Blank or Blank leading zeroes.

Fixed Decimal Point After Digit

Available selections are None, 1, 2, 3, 4, 5, 6, 7, or 8.

Number of Display Digits

Available selections are 2, 3, 4, 6, or 8.

Counter Mode

The function of Input 1, Input 2 and the reset input can be defined. Available options include count up, count down, reset, count / rate, quadrature X1 X2 and X4.

Input Active Level

The input active level for each input can be set to active high or active low.

Debounce Time

The debounce time of each input can be individually set. The debounce time is used to filter out false inputs due to contact bounce from a relay or switch input.

Counter Reload Value

Counter Reload value is the value that the unit will display when a reset input is received.

Scale Factor

A scale factor can be defined for each count input. The scale factor setting determines the amount that each input event will increment or decrement the display value.

Save on Power Down

Saving the current display value in memory upon loss of power can be enabled or disabled.

Count Below Zero

Counter modes defined with count down inputs can be defined to count below zero (negative numbers) or stop at zero.

Trigger Value

Two trigger values are available. When the display value crosses a trigger value, a number of operations can be simultaneously triggered. Available operations are two different flash rates, Relay activation, Stop counting, Reset to reload value or change display color (tri-color displays only).

Relay Setup

Relay Sequence A is user definable as either a Delay On Relay or Cycle Relay. The Delay On Relay selection allows adjustment of the delay and duration time. These settings are adjustable from .1 to 25.5 seconds. The Cycle Relay selection allows specifying the ON time (.1 to 25.5 seconds), OFF time (.1 to 25.5 seconds), and number of cycles (adjustable from 1 to 255 times).

Baud Rate

Available selections are 300, 600, 1200, 2400, 4800, 9600, 19200, or 57600.

Data Bits

Available selections are 7 or 8.

Terminator

The Terminator selection specifies which character ends the transmission. Available selections are <CR> or <LF>.

Unit Address

Unit Address allows you to select an individual unit address. Individual unit addresses can range from **0** to **255**, allowing up to 256 displays to be individually addressed in a network.

Member of Group(s)

Member of Group(s) allows you to select any combination of up to eight display groups that the display can belong to. A packet addressed to a specific group or combination of groups will only be acted on by displays belonging to the group(s). Available selections are 1 to 8.

Checksum

This is an optional part of the packet that can be used to provide an extra level of data validation. If used, the checksum immediately follows the Terminator character.

Command Acknowledgment

Command acknowledgments are used to let the host device know if data received by the display can be acted upon (i.e. the data is valid for the command transmitted, and the command and data are appropriate for the particular display). If checksums are being used, command acknowledgments also provide a means of letting the host device know that the data was received with a proper checksum.

Output Transmission

Output transmission data can be used to poll an auxiliary device for data, or send the display value to a remote computer. The format of the data to be transmitted and the transmit interval can be defined.

Appendix A Operating Specifications

LED Life	100,000 hours typical
Peak Wavelength	
Red	660nm
Yellow	592nm
Green	568nm

Count Input characteristics

High Level	3.5 to 30 VDC
Low Level	0 to 1.5 VDC
Input loading	1.5mA to 10mA (5V-30V)
Leakage current accepted	500 uA
Low Speed	50 Hz (10 millisecond on/off time)
High Speed	4000 Hz (120 microsecond on/off time)

Memory 100,000 Read / Write cycles, 100 year retention

Serial Input RS-232, RS-485 Optional

Optional Relay Output Single Pole Double Throw Rated 120VAC @ 1A

Power Supply 120 VAC +/- 15% (50 - 60 Hz)
12 VDC +/- 5%

Power Requirements All power requirements in the following table are listed in VA (Volt Amps).

Digit Type	Red Or Yellow Display				
	2 Digit	3 Digit	4 Digit	6 Digit	8 Digit
4" Discrete Segment	NA	6.62	8.3	11.65	15
4" Solid Segment	NA	13.25	16.6	23.3	30
6" Discrete Segment	9.9	13.25	16.6	23.3	30
8" Discrete Segment	14.84	19.87	24.9	34.95	45.01
12" Discrete Segment	19.79	26.49	33.2	46.6	60.01

For Green Displays, multiply the current value in the table by 1.25.
For Tri-Color Displays, multiply the current value in the table by 2.5.

Temperature Range Operating 32 to 122 degrees F (0 to 50 degrees C)

Humidity 5% to 95% non-condensing

Appendix B Character Set Listing

This table lists the full 87/256 character set in a standard ASCII format. As a primarily numeric, seven segment display, many non-numeric characters can be displayed in only a limited fashion. The hex and decimal ASCII codes are shown for each character. The upper and lower case alpha character sets are identical. They are designed to be as readable as possible, within the constraints of a seven segment display. If a character is not listed it will be displayed as blank (as will all characters 20h and below).

20h 32d	21h 33d	22h 34d	23h 35d	24h 36d	25h 37d	26h 38d	27h 39d
28h 40d	29h 41d	2Ah 42d	2Bh 43d	2Ch 44d	2Dh 45d	2Eh 46d	2Fh 47d
30h 48d	31h 49d	32h 50d	33h 51d	34h 52d	35h 53d	36h 54d	37h 55d
38h 56d	39h 57d	3Ah 58d	3Bh 59d	3Ch 60d	3Dh 61d	3Eh 62d	3Fh 63d
40h 64d	41h 65d	42h 66d	43h 67d	44h 68d	45h 69d	46h 70d	47h 71d
48h 72d	49h 73d	4Ah 74d	4Bh 75d	4Ch 76d	4Dh 77d	4Eh 78d	4Fh 79d
50h 80d	51h 81d	52h 82d	53h 83d	54h 84d	55h 85d	56h 86d	57h 87d
58h 88d	59h 89d	5Ah 90d	5Bh 91d	5Ch 92d	5Dh 93d	5Eh 94d	5Fh 95d
60h 96d	61h 97d	62h 98d	63h 99d	64h 100d	65h 101d	66h 102d	67h 103d
68h 104d	69h 105d	6Ah 106d	6Bh 107d	6Ch 108d	6Dh 109d	6Eh 110d	6Fh 111d
70h 112d	71h 113d	72h 114d	73h 115d	74h 116d	75h 117d	76h 118d	77h 119d
78h 120d	79h 121d	7Ah 122d	7Bh 123d	7Ch 124d	7Dh 125d	7Eh 126d	7Fh 127d

Appendix C Display Dimensions

The 87 Series display was designed to be suspended from a pair of chains. Make sure that the supporting chain can support the weight of the display. Failure to follow this warning could result in damage to property, or personal injury.

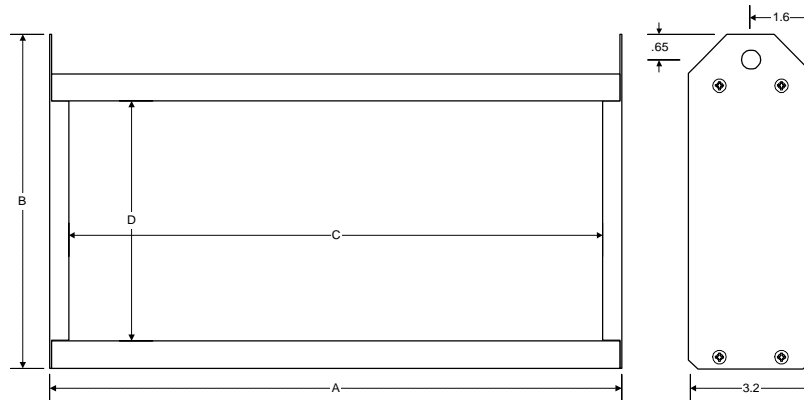

	A	B	C	D
4" Display 3 Digit	12.75	8.40	11.75	5.70
4" Display 4 Digit	16.30	8.40	15.30	5.70
4" Display 6 Digit	23.40	8.40	22.40	5.70
4" Display 8 Digit	30.50	8.40	29.50	5.70
4" Display 12 Digit	44.70	8.40	43.70	5.70
4" Display 16 Digit	58.90	8.40	57.90	5.70
4" Display 20 Digit	73.10	8.40	72.10	5.70
6" Display 2 Digit	12.90	10.40	11.90	7.70
6" Display 3 Digit	18.30	10.40	17.30	7.70
6" Display 4 Digit	23.70	10.40	22.70	7.70
6" Display 6 Digit	34.50	10.40	33.50	7.70
6" Display 8 Digit	45.30	10.40	44.30	7.70
8" Display 2 Digit	15.90	12.40	14.90	9.70
8" Display 3 Digit	22.80	12.40	21.80	9.70
8" Display 4 Digit	29.70	12.40	28.70	9.70
8" Display 6 Digit	43.50	12.40	42.50	9.70
8" Display 8 Digit	57.30	12.40	56.30	9.70
12" Display 2 Digit	22.80	16.40	21.80	13.70
12" Display 3 Digit	33.15	16.40	32.15	13.70
12" Display 4 Digit	43.50	16.40	42.50	13.70
12" Display 6 Digit	64.20	16.40	63.20	13.70
12" Display 8 Digit	84.90	16.40	83.90	13.70