

Install XL

Software Version 2.20

Audience: This guide is for the electrician installing the Vorne XL Productivity Appliance™.

Purpose: To accomplish:

- Hanging XL
- Connecting XL to the network, and
- Obtaining signals from the manufacturing process.

Table of Contents

Important User Information	3
Contact Information	4
Prepare to Install XL.....	5
1) Gather Necessary Equipment.....	5
2) Identify Installation Locations.....	6
Connect XL to Your Process	7
1) Mount the Device	7
2) Remove Access Plate	7
3) Connect Digital Inputs.....	8
4) Connect 2D Barcode Scanner	10
5) Connect Ethernet Port	10
6) Reinstall Access Plate	10
7) European Union: Install Clamp-On Ferrite Core	11
8) Step 8 – Apply Power	11
9) Test 2D Barcode Scanner	11
Appendix A – Relay Output	12
Appendix B – DIP Switch Settings	13
Appendix C – Specifications.....	14
EU Declaration of Conformity	15

Important User Information

XL products are not designed or intended for control applications and **MUST NOT** be used for control applications under any circumstances. There are fundamental differences in the design methodology of a control product such as a Programmable Logic Controller (PLC) and a non-control product such as an XL device. Outputs (e.g., relays) are provided for annunciation only, and **MUST NOT** be used for control purposes.

This product is designed and intended for use solely in indoor industrial applications and **MUST** be installed by a qualified electrician.

This product is designed and intended for use solely in a secure, private network environment.

It is the responsibility of all persons applying this product to a given installation and/or application to carefully review the installation and/or application to evaluate and ensure the suitability of this product for the intended application.

This documentation, including any examples, diagrams, and drawings, is intended to provide information for illustrative purposes only. Because of the differences and varying requirements of different installations and applications, Vorne Industries, Inc. cannot assume responsibility or liability for actual use, including use based on any examples, diagrams, and drawings.

In no event will Vorne Industries, Inc. be responsible or liable for indirect or consequential damages resulting from the use or application of this product. Please carefully review the Vorne Product Warranty Statement at www.vorne.com/warranty.htm and the Vorne Sales Terms and Conditions at www.vorne.com/terms.htm. Vorne Industries, Inc. makes no warranties express or implied except as expressly stipulated in our Product Warranty Statement.

While the information in this document has been carefully reviewed for accuracy, Vorne Industries, Inc. assumes no liability for any errors or omissions in the information.

Vorne Industries, Inc. reserves the right to make changes without further notice to any products described in this documentation.

Important Legal Notice: US Patents US9100248, US9633135, US9864961, US10909480 EP Patents EP2145452, EP2381649, Canadian Patents CA2686313, CA2786004, CA2911316, Mexican Patents MX381115, MX354053, Chinese Patent ZL201810151892.3. Additional patents pending. Copyright © 2025 Vorne Industries, Inc. Vorne, XL and other Vorne Industries, Inc. trademarks described herein are the exclusive property of Vorne Industries, Inc. All other trademarks are the property of their respective owners. This product and its associated software and documentation (collectively “the Product”) contains Vorne Industries, Inc. proprietary material, and is further protected by statute and applicable international treaties. The Product may not be reverse engineered or used in any manner for competitive purposes without the prior express written consent of Vorne Industries, Inc. Any rights not expressly granted herein are reserved.



MULTIPLE POWER SOURCES: This product has more than one source of power. Relay outputs may be at mains potential from a secondary power source. Always disconnect power from all power sources before installing or servicing the XL device, and before opening the user access plate.



SHOCK HAZARD: To avoid risk of shock, always disconnect all sources of power before installing or servicing the XL device, and before opening the user access plate. Do not reapply power until the access plate has been reinstalled and securely closed. Failure to follow these precautions could result in personal injury or death due to electric shock.



ATTENTION: This product must be operated at or below Pollution Degree 2 (an environment where only non-conductive pollution occurs except for occasional and temporary conductivity caused by condensation) and Over Voltage Category II (circuits directly connected to local-level distribution).

Contact Information

Corporate Office

Address: Vorne Industries, Inc.
1445 Industrial Drive
Itasca, IL 60143-1849, USA

Phone: +1.630.875.3600

Fax: +1.630.875.3609

Website: www.vorne.com

Sales and Support (USA and Canada)

We are available Monday through Friday from 8:00 AM to 6:00 PM CST (UTC-6:00).

Main Phone: +1.630.875.3600

Sales Email: sales@vorne.com

Support Email: support@vorne.com

Sales and Support (European Union)

Within the European Union, Vorne products are distributed by the following companies:

Company Name	Office Location
Action Coaching International	Koningin Astridlaan 74, 2820 Bonheiden, Belgium
LineView Solutions	Innovation Campus, 33 Greenhill, Blackwell, Bromsgrove, B60 1BL United Kingdom
TQMSoft	ul. Bociana 22a, 31-231 Kraków, NIP 676-11-58-054, Poland

Sales and Support (International)

Vorne has an extensive network of international partners. More information can be found at: <https://www.vorne.com/about-us/xl-partners.htm>.

Prepare to Install XL

1) Gather Necessary Equipment

Provided by Vorne

Item	Description
XL Productivity Appliance™	Your XL device, which includes an integrated scoreboard, digital I/O, production monitor, data warehouse, web server, and browser-based reporting platform.
XL Power Cord	Detachable power cord with IEC female connector.
Ferrite Cable Clamp	Cylindrical ferrite clamp. (Included only for products sold within the European Union)
XL Documentation	Includes: <ul style="list-style-type: none">▪ Install XL for the electrician installing XL (this manual)▪ Configure XL for the person responsible for driving improvement with XL▪ Meet XL for the person who wants a deeper understanding of the XL platform
XL Barcode Kit (optional)	<i>Optional, but highly recommended.</i> Includes 2D barcode scanner, XL interface cable, and AC adapter. In most applications, the operator uses a 2D barcode scanner to scan down reasons and start new part runs. The 2D barcode scanner can also be used to scan the start of changeovers and/or log rejects (counts and reasons).

Provided by You

Item	Description
Digital Inputs	For most applications, XL requires a pulsing 5-24V DC digital input. This input is used by XL to calculate counts and to track cycles. (see next section for more information) Optionally, a second Out Count digital input can be provided to track OEE Quality. This signal can be generated by either one or more Reject Count sensors, a Good Count sensor, or the 2D barcode scanner. If the process does not have the capability to provide a pulsing count signal, XL can receive a run/down signal. Refer to the Deploy XL: Manual Run Detection document for more information.
Network Drop	Network connection for CAT5 or better Ethernet cable.
Ethernet Cable	CAT5 or better Ethernet cable. Straight-through or crossover.
Mounting Hardware	Refer to Step 1 – Mount the Device for more information.



To help you select the appropriate sensor(s) for your application, reference our [Tech Note](#).

LINK

2) Identify Installation Locations

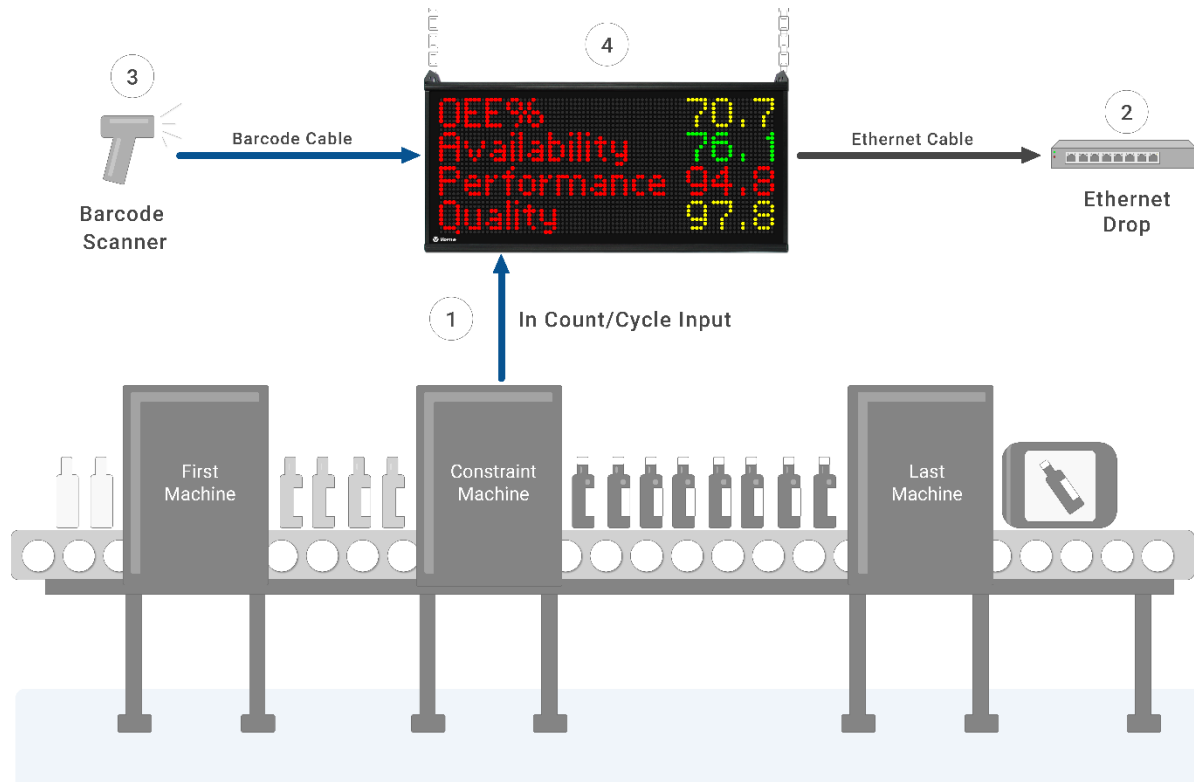

There are four locations to identify before starting the installation. Determine where the following will be located:

1. **Digital inputs** - used to connect XL to your process (more in the **next** section).
2. **Ethernet drop** - used to access the XL web page interface.
3. **2D barcode scanner** - used by operators to enter down reasons. Place the 2D barcode scanner near where the operator restarts the process after a stop.
4. **XL Productivity Appliance™** - determine the optimum location for viewing across the manufacturing process.

Identify Signal Requirements for Digital Inputs

Signal requirements can vary greatly based on specific application, but most will use 1 or 2 sensors total. See below for requirements and options.

Type	Required	Description
In Count	Yes	Counts pieces entering the process; often combined with Cycle Input
Cycle Input	Yes	Measures cycles and to detect slow cycles, small stops, and Down Time; can be a standalone counter or combined with <i>one</i> other input (typically In Count)
Out Count (Good or Reject)	Optional, but required to track OEE Quality	Counts pieces exiting the process; can be configured as either Good Count or Reject Count, but not both; can be taken from a single or multiple points of the manufacturing process.
End of Line Count	Optional	A standalone counter typically used to count packaged product at the end of the manufacturing process; not used in quality measurement

Connect XL to Your Process

1) Mount the Device

You may choose to mount the device first, or you may wish to configure and connect the device to your process first. The XL device is designed to be hang-mounted (i.e., suspended from a pair of chains).

- Chain must have a working load limit of not less than 400 pounds (182 kilograms).
- Chain material must be appropriate for the environment; for example, type 304L stainless steel for severe environments.
- Chain must be attached to each of the two end plates of the XL device through the provided mounting holes, each measuring a nominal 0.5" (12.7 mm) in diameter.

Attachment to the support structure and attachment to the XL device must use attaching devices (e.g., shackles) with the same working load limit and material considerations as described above.

Attachment points to the support structure should be at the same spacing as the width of the XL device (i.e., the same spacing as between the XL device end plates).



WARNING: Make sure that the supporting chain and attaching devices meet the above specifications. Failure to follow this warning could result in damage to property, personal injury, or death.

2) Remove Access Plate



MULTIPLE POWER SOURCES: This product has more than one source of power. Relay outputs may be at mains potential from a secondary power source. Always disconnect power from all power sources before installing or servicing the XL device, and before opening the user access plate.



SHOCK HAZARD: To avoid risk of shock, always disconnect all sources of power before installing or servicing the XL device, and before opening the user access plate. Do not reapply power until the access plate has been reinstalled and securely closed. Failure to follow these precautions could result in personal injury or death due to electric shock.



CAUTION: Keep mains-connected wiring (including relay output wiring) separate from signal and I/O wiring. Use the left knockout(s) for mains-connected wiring (including relay output wiring) and the right knockout for signal and I/O wiring.



CAUTION: Take care to pass all wiring through the back panel knockouts using cable glands that meet local electrical code. Make sure that any unused knockouts are plugged using hardware that meets local electrical code.

1. Verify that all sources of power have been completely disconnected from the XL device.
2. Remove and save the screws holding the access plate (eight to ten screws, depending on model).
3. Gently pull the access plate away from the XL device. The access plate will remain connected to the XL device via its grounding strap.

Take Note of Connector Locations

For the installation, you will need to connect:

- **RS-232** (for the 2D barcode scanner)
- **High Speed Input Terminal** (to provide XL with digital inputs)
- **10/100 Ethernet** (to access XL over the network)

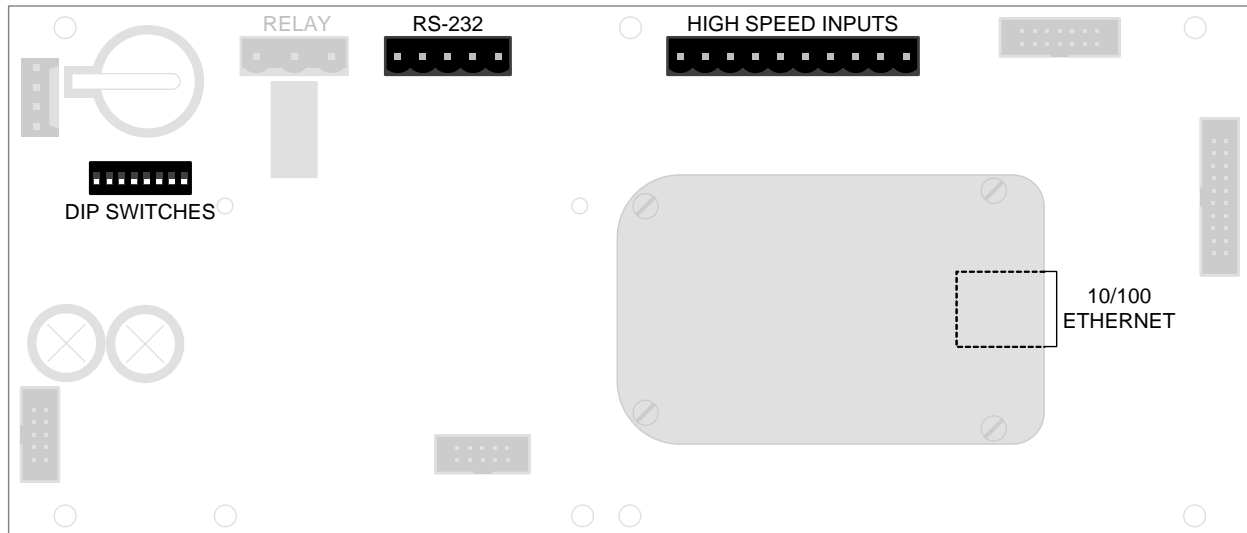

3) Connect Digital Inputs

Overview

XL uses either Sinking (NPN) or Sourcing (PNP) digital inputs. If providing multiple digital inputs (see below), inputs must all be either sinking or sourcing. The maximum signal frequency is 4,000 Hz.

Example signals include: photoelectric sensors, proximity switches, relays, PLC (Programmable Logic Controller) outputs, or other devices that are physically appropriate for their manufacturing environment.

Connections

Wire your digital inputs to the 10-pin terminal block marked "HIGH SPEED INPUTS". This terminal block can be unplugged from the logic board to make wiring easier. Refer to the [previous chapter](#) for guidance on which dedicated digital inputs to connect:

- In Count (required; can also function as the Cycle Input)
- Out Count (optional; required for quality metrics if not manually scanning reject reasons)
- Cycle Input (optional; for multiple-step manufacturing processes)
- End of Line Count (optional; to provide standalone count of finished goods at the end of the process, typically in case or pallet context)

Wiring Diagrams

Sinking (NPN) Outputs

Sensors are connected to power from the XL device. In Count and Reject Count are shown (additional sensors may be connected in the same way).

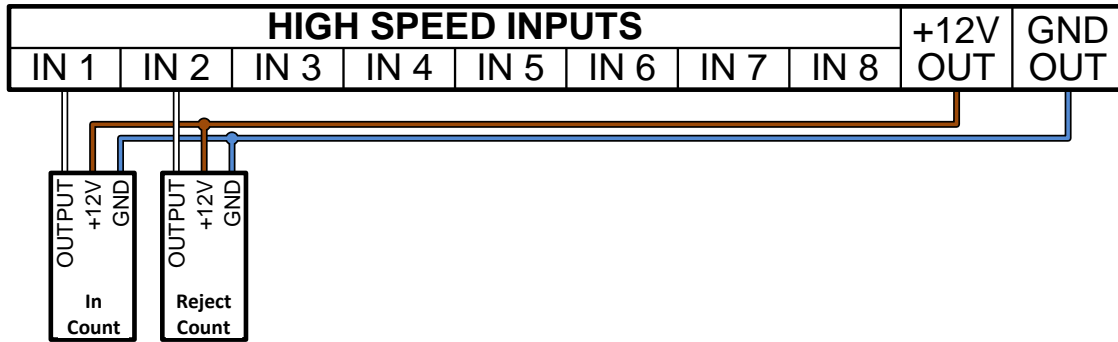

Sourcing (PNP) Outputs

Sensors are connected to power from the XL device. In Count and Reject Count are shown (additional sensors may be connected in the same way).

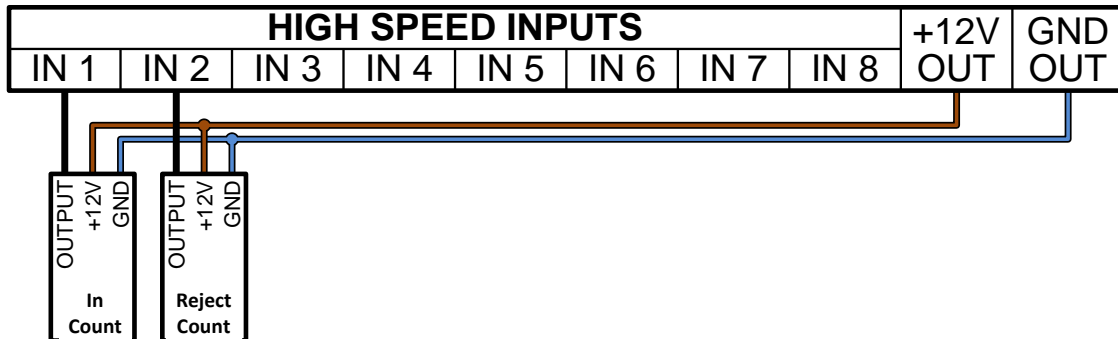

PLC Outputs

- A shared DC Ground must be established between the PLC and the XL device.
- PLC Outputs should be connected to High Speed Inputs in the Terminal Block. Ex: In Count and Reject Count are shown (additional PLC outputs may be connected in the same way).

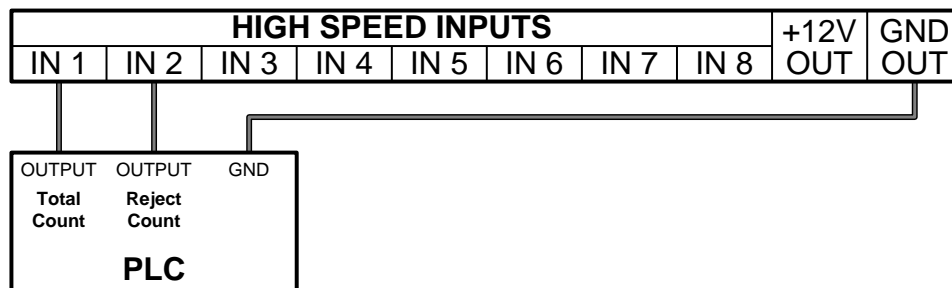

4) Connect 2D Barcode Scanner

XL is designed to interface to 2D barcode scanners with an RS-232 output. The following instructions are based on XL Barcode Kits from Vorne.

1. Wire the XL barcode interface cable to the 5-pin terminal block marked "RS-232". This terminal block can be unplugged to make wiring easier:
 - Red wire to pin 1 (RxD1 ~ XL Receive Data).
 - Green wire to pin 2 (TxD1 ~ XL Transmit Data).
 - Black wire to pin 3 (GND ~ XL Ground).

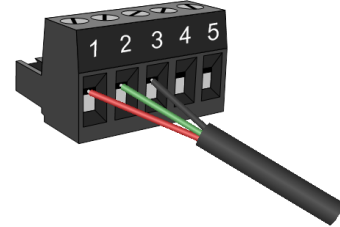

2. Plug the male 9-pin D-sub connector at the end of the XL interface cable into the female 9-pin D-sub connector of the 2D barcode scanner.
3. Plug the barrel connector of the AC adapter into its mating DC power receptacle in the 2D barcode scanner:
 - Wired Scanners (the DC power receptacle is located on the back of the D-sub connector).

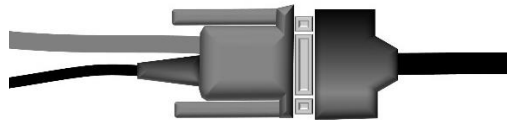

- Wireless Scanners (the DC power receptacle is located on the base unit).
4. Plug the AC adapter into an AC power outlet.

5) Connect Ethernet Port

The XL device includes a 10/100 Ethernet port, which is used to connect XL to your local network. This port supports Auto-MDIX (automatic crossover) so either a straight-through or crossover cable can be used.

1. Gently plug one end of the Ethernet cable into the RJ45 jack on the XL logic board, latch side up (away from the board).
2. Plug the other end of the Ethernet cable into your local network drop.

6) Reinstall Access Plate

Fasten the access plate to the back panel using the screws that were removed in [Step 2 – Remove Access Plate](#).

7) European Union: Install Clamp-On Ferrite Core



ATTENTION: A ferrite core must be installed on cables connected to Ethernet Cable to meet EU EMI suppression requirements.

A clamp-on ferrite core is provided with XL systems sold within the European Union. The Ethernet cable should be wrapped twice around the ferrite core.

1. Open the clamp-on ferrite core.
2. Position the ferrite core outside the XL system, as close as possible to where the signal wires exit the back panel.
3. Wrap the Ethernet cable twice through the ferrite core.
4. Close the ferrite core around the Ethernet cable.

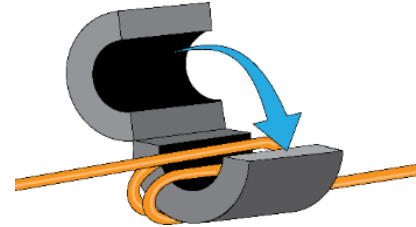

8) Step 8 – Apply Power



SHOCK HAZARD: This product must be grounded. Never defeat the ground conductor or operate the product in the absence of a suitably installed ground conductor.



ATTENTION: This product is suitable for connection to a TN-S power distribution system (AC Hot and AC Neutral lines with a separate protective grounding conductor).



ATTENTION: Refer to [Appendix C – Specifications](#) for power requirements.

1. Apply mains power to the XL device.
2. Verify that the XL scoreboard lights up and starts showing information. The format of the information will depend on the XL model.

9) Test 2D Barcode Scanner

Scan this barcode to test the 2D barcode scanner and its connection to XL. The barcode scanner will beep, and the XL scoreboard will show the text “Barcode Pass” for 5 seconds:



Appendix A – Relay Output



WARNING: XL products are not designed or intended for control applications, and **MUST NOT** be used for control applications under any circumstances. Outputs (e.g., relays) are provided for annunciation only, and **MUST NOT** be used for control purposes.



CAUTION: Keep mains-connected wiring (including relay output wiring) separate from signal and I/O wiring. Use the left knockout for mains-connected wiring (including relay output wiring) and the right knockout for signal and I/O wiring.



CAUTION: Carefully route relay output wiring to keep it away from electronic components inside the enclosure.

Relay Output Operation

XL devices have one relay output on the main logic board. The relay output is intended to alert operators to down time, and to prompt them to scan a reason for a down event.

The relay behavior can be configured in the **Settings > Connections > Relay Output** page in the XL Web Page Interface. The relay can be configured as follows:

- When down time is detected, turn the relay on immediately. Turn off when a reason is scanned.
- When down time is detected, turn the relay on only after the process is running. Turn off when a reason is scanned, or a new down event is started.

Relay Output Wiring

The relay output must only be used with a **resistive load**.

The current per relay contact must not exceed 1 Amp, and the voltage per relay contact must not exceed 30 VDC or 250 VAC.

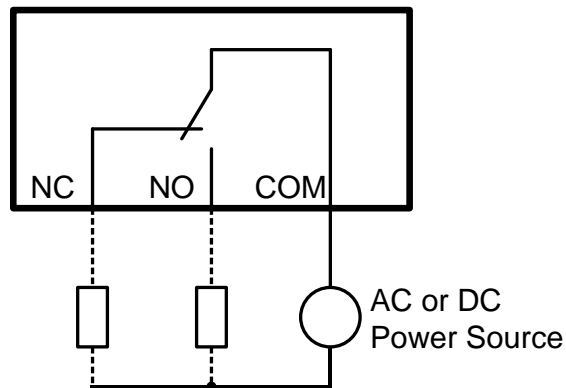

Appendix B – DIP Switch Settings

All DIP Switches should be **OFF** for regular operation. Changes to DIP switch settings are recognized **only** at XL power-up. Carefully review the information in the table below before making any changes to DIP switch settings.



MULTIPLE POWER SOURCES: This product has more than one source of power. Relay outputs may be at mains potential from a secondary power source. Always disconnect power from all power sources before installing or servicing the XL device, and before opening the user access plate.



SHOCK HAZARD: To avoid risk of shock, always disconnect all sources of power before installing or servicing the XL device, and before opening the user access plate. Do not reapply power until the access plate has been reinstalled and securely closed. Failure to follow these precautions could result in personal injury or death due to electric shock.

Switch	Function	Description
1	Password Recovery	Enables password recovery. OFF – Default ON – Password Recovery
2	None	Reserved
3	None	Reserved
4	None	Reserved
5	None	Reserved
6	None	Reserved
7	None	Reserved
8	Lamp Test	Turns on all LEDs on the scoreboard for visual verification. OFF – Default ON – Lamp Test

Appendix C – Specifications

Operating Conditions

Item	Specification
Power	100 to 240 VAC, 50 to 60 Hz (power and current requirements for each model are shown in Model-Specific Specifications below).
Ambient Temperature	32°F to 122°F (0°C to 50°C)
Relative Humidity	5% to 95% Non-Condensing

Inputs and Outputs

Digital Inputs are configured through the XL web page interface by navigating to **Settings > Connections > Digital Inputs**. Refer to the **Configure XL** guide for step-by-step instructions.

Item	Specification
High Speed Inputs	(8) Digital Inputs, 5 to 24 VDC, port is configurable as Sink or Source via browser Low Speed (50 Hz max) or High Speed (4,000 Hz max) configurable via browser
Relay Output	(1) SPDT Relay, 30 VDC or 250 VAC at 1A (max), Resistive load only
+12 VDC Power Out	Supplies 100 ma (max) for sensors

Communication Ports

Communication ports are configured through the XL web page interface by navigating to **Settings > Connections > Ethernet**.

Item	Specification
Ethernet	IEEE 802.3, 10/100 Mbps, Auto-MDIX, RJ-45
Serial Ports	(2) RS-232, 300 to 115.2k baud, Full-Duplex

Model-Specific Specifications

All models include tricolor scoreboards (green, red, amber). The specified power represents maximum power (all LEDs on).

Model	Display Configuration	Dimensions – W x H x D	Weight	Power
XL810-1	Alphanumeric, 80-Column	26.2 x 13.7 x 3.5 in (67 x 35 x 9 cm)	19 lb (8.6 kg)	80 W
XL810-2	Alphanumeric, 160-Column	50.2 x 13.7 x 3.5 in (128 x 35 x 9 cm)	33 lb (15.0 kg)	160 W
XL610	Digital, 3-Line x 6-Digit 2.3 in (5.8 cm)	31.0 x 15.9 x 3.5 in (79 x 40 x 9 cm)	23 lb (10.4 kg)	50 W
XL410	Digital, 1-Line x 6-Digit 4.0 in (10.1 cm)	23.4 x 8.4 x 3.5 in (59 x 21 x 9 cm)	9 lb (4.1 kg)	30 W



EU Declaration of Conformity

Name and Address of the manufacturer:

Vorne Industries
1445 Industrial Drive
USA 60143
Itasca, Illinois

Tel: +1.630.875.3600
Email: support@vorne.com

This declaration of conformity is issued under the sole responsibility of Vorne Industries, Inc.

OBJECT OF THE DECLARATION	
Type of Object:	Production Monitoring System
Regulatory Model:	XL810-1 Productivity Appliance
Regulatory Name:	XL810-1
Trade/Manufacturer Name:	Vorne Industries

The object of the declaration described above is in conformity with the following directives and regulations:

DIRECTIVE 2014/30/EU OF THE EUROPEAN PARLIAMENT AND OF THE COUNCIL of 26 February 2014 on the harmonization of the laws of the Member States relating to electromagnetic compatibility.

DIRECTIVE 2014/35/EU OF THE EUROPEAN PARLIAMENT AND OF THE COUNCIL of 26 February 2014 on the harmonization of the laws of the Member States relating to the making available on the market of electrical equipment designed for use within certain voltage limits.

DIRECTIVE 2011/65/EU OF THE EUROPEAN PARLIAMENT AND OF THE COUNCIL of 8 June 2011 on the restriction of the use of certain hazardous substances (RoHS) in electrical and electronic equipment, and all its amendments as of this documents date of issue included (but not limited to) amending directive 2015/863.

REGULATION (EC) 1907/2006 of the European Parliament and of the Council of 18 December 2006 concerning the Registration, Evaluation, Authorization and Restriction of Chemicals (REACH).

The object of the declaration described above has been assessed and found in compliance with the following harmonized standards, regulations, and technical references:

SAFETY	EN 62368-1:2014/AC:2015
EMC	EN 61326-1:2013 (Group 1, Class A) EN 55011:2016/A1:2017+A11:2020 (Class A)
RoHS	EN IEC 63000:2018
Itasca, Illinois, USA	<i>Norman Vorne</i>
Place of Issue	Signed for and on behalf of Vorne Industries, Inc.
July 18, 2024	Norman Vorne (VP)
Date of Issue	Full Printed Name (Position)

SUPPLEMENTARY INFORMATION: The object of this declaration has been tested and found to comply with the electromagnetic compatibility (EMC) limits for a Group 1, Class A device as listed in EN 61326 above. The object of this declaration has been evaluated and found to be out of scope for Energy Efficiency and Ecodesign standards.

Vorne Industries
1445 Industrial Drive
Itasca, IL 60143-1849
USA